

DRILLED AND TAPPED FOR 3/4" OR 1" POWER HUB ANCHOR ROD

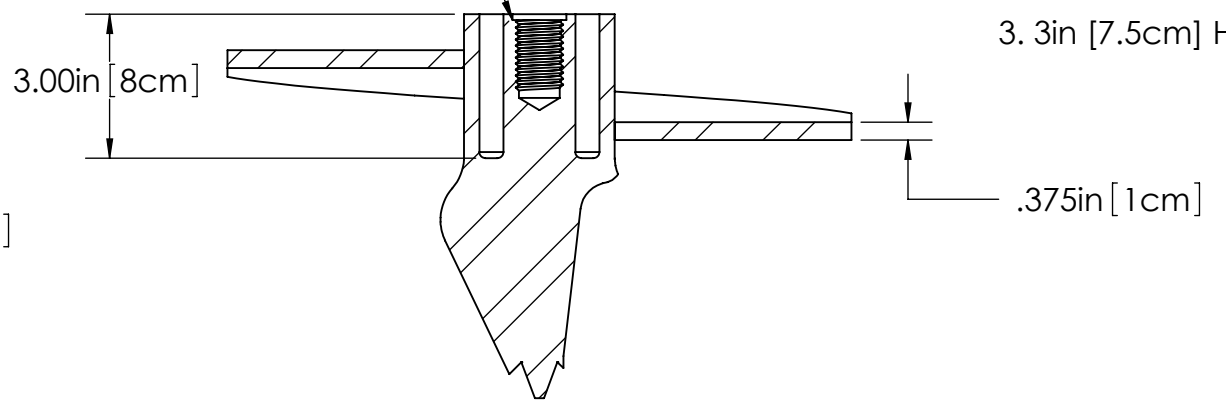

SECTION A-A

NOTES:

1. PAINT DARK GREEN AFTER FABRICATION.
2. TORQUE RATING - 15,000 FT-LBS (20,337 Nm).
3. 3in [7.5cm] HELIX PITCH.

This drawing contains confidential information that is the property of MacLean Power, L.L.C. ("MacLean"). Use of MacLean's confidential information without MacLean's express written consent is strictly prohibited and may expose you to legal liability. If you believe that you received this material in error, please destroy it or return it to "MacLean Power, L.L.C., 11411 Addison Street, Franklin Park, Illinois 60131, "USA."



DRAWING NUMBER:		TD250-134
SHEET NAME:	SHEET1	1 OF 1
PRODUCT DESCRIPTION		
2-1/2" POWER HUB SOCKET DRIVE TURBO DRIVE® ANCHOR		
DRAWN BY:	CRL	DATE: 3/12/12